

Secure protocol support Visualize network environment with peace of mind



Network Error Notification

Reports errors in network devices and systems. Instant notification with light and sound.

New Compatible with Secure Protocols

Supports secure protocols such as HTTPS, SNMP v3, SSH, OAuth 2.0. Secure communication with peace of mind.



New Expanded Lineup

Select models suitable for your needs, such as, email detection or PoE compatibility.



New New Features

Added features for improved usability.



Network Signal Tower with Voice Annunciator

NHV series

- Compatible with various protocols
- Suitable for messages or melodies
- Diverse lineup

Software Features	HTTPS	SNMP	SSH	OAuth	SOCKET	PING	Web Browser Settings
	HTTP	V3/v2c/v1	RSH	2.0		24	
Hardware Features	Send E-mail	Detect E-mail	Text to Speech	IP v6/v4	Azure	AWS	
	RJ-45	Φ40 (NHV4)	Φ60 (NHV6)	Digital Contacts 4 Inputs 2 Outputs	PoE	88dB	

(* Use Google Chrome/Microsoft Edge when setting up browsers.)

Download User Manuals and Specifications

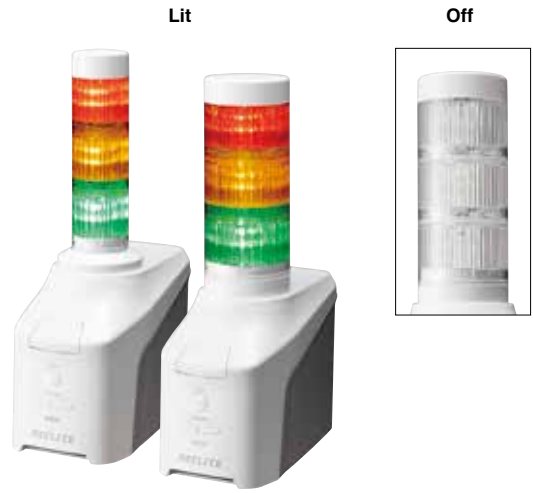

Model Number Configuration

NHV4-3D□N-RYG

① ② ③ ④ ⑤ ⑥

① 4 = Signal Tower Φ40 6 = Signal Tower Φ60	④ None = Standard specification M = E-mail detection	⑥ 3 tiers = RYG
② 0 or 3 tiers	⑤ N = No AC adapter P = No AC adapter (Supports PoE power supply)	
③ None = No contact input/output D = Contact input/output		

NHV (Voice-enabled)



Standard model with high network security.

Product List	Φ40 Signal Tower	Φ60 Signal Tower
No AC adapter	NHV4-0N NHV4-3N-RYG	NHV6-0N NHV6-3N-RYG

NHV-D (Voice-enabled, Digital IO)

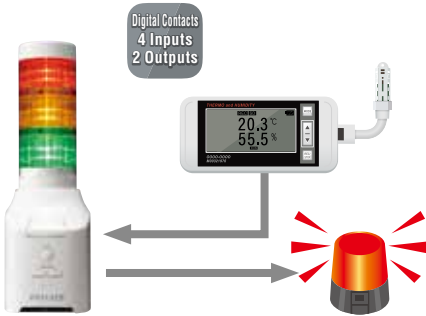

Standard NHV model plus 4 digital inputs and 2 digital outputs. Compatible with a wide range of applications, such as receiving outputs from sensors or controlling another device when the NHV is lit by sending digital contact outputs.

Product List	Φ40 Signal Tower	Φ60 Signal Tower
No AC adapter	NHV4-0DN NHV4-3DN-RYG	NHV6-0DN NHV6-3DN-RYG

NHV-DP (Voice-enabled, Digital IO, PoE Power)

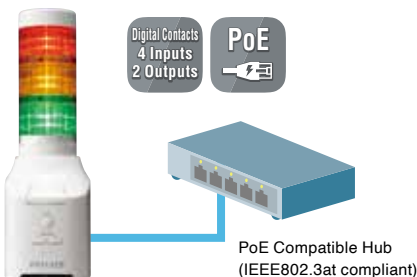

NHV-D plus PoE power capability. It can be used in areas where it is difficult to secure power supply or to facilitate network camera connection. (IEEE802.3 at compliant) Can also be used with optional ADP-001 power adapter.

Product List	Φ40 Signal Tower	Φ60 Signal Tower
PoE power supply (No AC adapter)	NHV4-0DP NHV4-3DP-RYG	NHV6-0DP NHV6-3DP-RYG

NHV-M (Voice-enabled, Mail Detection)



The NHV-M unit accesses the mail server and will light up or play a message when emails that meet preset conditions are received.

Product List	Φ40 Signal Tower	Φ60 Signal Tower
No AC adapter	NHV4-0MN	NHV6-0MN
	NHV4-3MN-RYG	NHV6-3MN-RYG

Optional Parts



Wall Mount Bracket
NH-001



Partition Mounting Bracket
NH-002



AC Adapter
ADP-001

Adding/Reconfiguring LED Unit

Easily add, remove or reconfigure LED units by simply turning them by hand. No tools are required.

Compatible with LR4 / LR6 series LED units. Clear lens and colored lens available. NHV6 also supports multi-color LED units.

Φ60 LED Unit for NHV6



Clear lens
Model Number : LR6-E-□
□ : RZ/YZ/GZ/BZ
Red / Amber / Green / Blue



Colored lens
Model Number : LR6-E-□
□ : R/Y/G/B/C
Red / Amber / Green / Blue / White

Φ40 LED Unit for NHV4



Clear lens
Model Number : LR4-E-□
□ : RZ/YZ/GZ/BZ
Red / Amber / Green / Blue



Colored lens
Model Number : LR4-E-□
□ : R/Y/G/B/C
Red / Amber / Green / Blue / White

- A maximum of 5 LED Units (LR□-E-□) can be installed.
- Units other than supported LED Units cannot be connected.
- Multiple LED units (LR□-E-□) of the same color cannot be connected.

Φ60 Multi-color LED Unit for NHV6

Display seven colors with a 1-tier Multi-color LED Unit.
Model Number : LR6-E-MZ

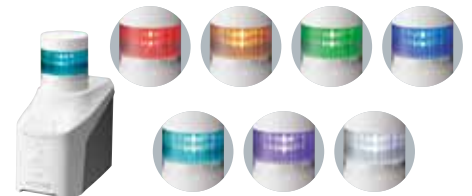

* WDT-6LR-Z2 cannot be used when the multi-color LED unit is used.

Dimming Function

4-level brightness adjustment function

Factories and other similar locations, require LEDs to be bright so they can be seen from a distance.

However, in offices or places where people are close to the unit, the LEDs need to be dimmer.

The NHV series offers four brightness settings so the appropriate light intensity can be set for your situation.

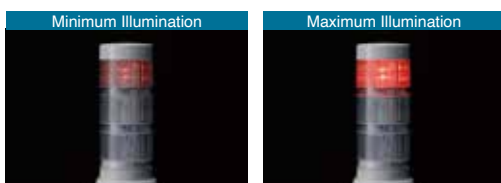

* The maximum luminous intensity is displayed when the Multi-color LED unit or WDT unit is mounted and cannot be changed. (Dimming function cannot be selected.)

WD Series Data Collection

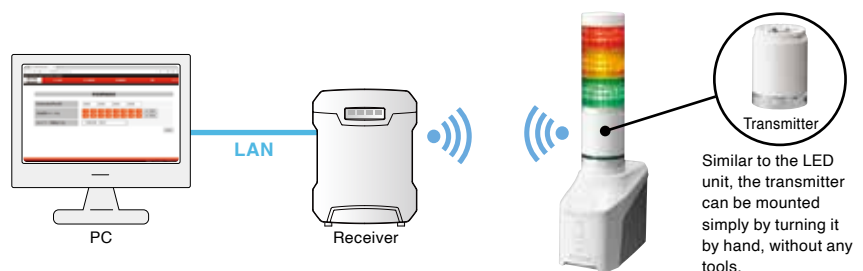

The WD series, a part of PATLITE's IoT offering, can be used.

The LED status is transmitted wirelessly from the transmitter mounted on the NHV to a dedicated receiver, and data is stored.

Nothing needs to be added to the existing system.



Basic Common Functions

SNMP TRAP Receive Function

SNMP TRAP from network-compatible devices (such as UPSs, printers, routers, and switches) are received to promptly notify the administrator of errors and faults with light and sound.

- Determine variable-bindings.
- Register up to 16 groups (4 nodes per group).

SNMP Status Monitoring

Actively get Device Status

Equipped with an SNMP device monitoring function in addition to dead/alive monitoring by PING monitoring. When the MIB information of the network device is actively acquired and the set conditions are met, the administrator is notified immediately by light and sound.

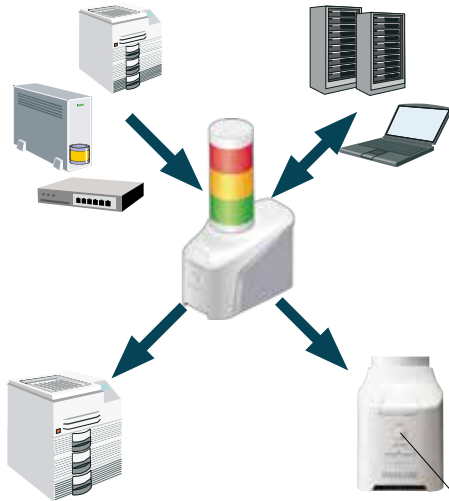

PING Monitoring

Each NHV unit can PING up to 24 devices. If a line failure to a node or a response from a monitored device cannot be obtained, the NHV considers it as an error and notifies the administrator quickly with light and sound.

Self-diagnosis Function

The test button on the front of the unit can be used to easily check the operation of the indicator light and alarm functions without control from the network.

Test Button

Extensive Communication Commands

HTTPS/HTTP

All notification patterns can be controlled by HTTPS/HTTP communication commands.

Receive Command Example

(Red continuous on / Amber flashing 1 • CH 10 message is played once)
<https://192.168.10.1/api/control?led=12000&sound=10>

Receive Command Example (Clear operation)

<http://192.168.10.1/api/control?clear=1>

Receive Command Example (Digital output ON)

<http://192.168.10.1/api/control?output=1>

* Digital Outputs are for D / DP Models Only

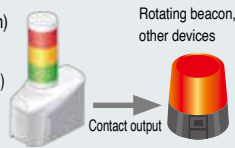

Cloud Communication

Supported Cloud Platforms: AWS, Microsoft Azure

AWS: Connect to AWS IoT Core

Azure: Connect to Azure IoT Hub/Azure IoT Central

Control LEDs and audio directly from the connected cloud service.

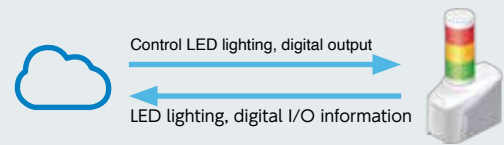

SSH/RSH

Can be easily controlled by SSH/RSH, which is a general-purpose protocol. Event information from integrated network management software or various monitoring tools can be used as triggers to turn on/flash lights and sounds.

SSH Command

Receive Command Example
 (Red, Amber, Green continuous on; Alarm sounds)

`ssh 192.168.10.1 -l root alert 111001`

RSH Command

Receive Command Example
 (Red, Amber, Green continuous on; Alarm sounds)

`rsh 192.168.10.1 -l root alert 111001`



SOCKET Communication

Controlled by PATLITE's proprietary SOCKET communication commands, PNS and PHN commands. These commands can be used directly on existing systems.

PNS Command

All notification patterns can be controlled.

Receive Command Example

(Red, Amber, Green continuous on; Alarm sounds)
`58H,58H,53H,00H,00H,06H,01H,01H,01H,00H,00H,01H`

PHN Command

Simple command control with 2 bytes.

* Some functions are restricted.

Receive Command Example

(Red, Amber, Green continuous on; Alarm sounds)
`57H,17H
 (W) (00010111)`



Send HTTPS/HTTP Commands

Easier to control in conjunction with other products

HTTPS / HTTP commands can be sent from NHV. Controlling another NHV or a separate PATLITE product is possible. It is also possible to link with products that can receive HTTPS / HTTP commands, such as cameras from other companies.

Number of registrations : 8

Number of command characters : Up to 128 characters per command

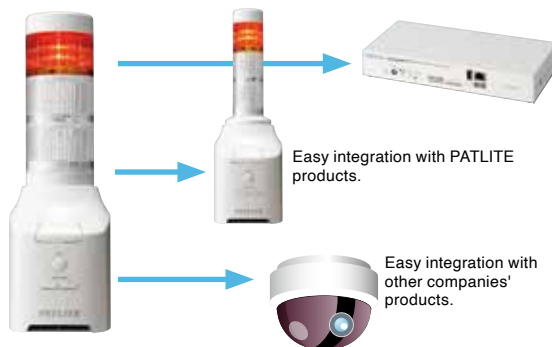

Easy integration with PATLITE products.

Easy integration with other companies' products.

Detailed Notification Settings

E-mail



Send e-mail

Send up to 8 e-mails per event

Customize subject and message for various events. Enhanced e-mail authentication features provide superior security. Supports OAuth 2.0 authentication / password authentication (OAuth authentication only supports Gmail / Outlook)

Send SNMP TRAP/Inform

Send up to 8 locations.

- SNMP v1/v2c/v3



Voice Function – MP3 Playback Function –

The MP3 playback function enables notification with voice messages. Detailed emergency information and voice guidance can be played back.

Text To Speech

TTS (Text to Speech)



This unit is equipped with a "Text to Speech (TTS)" function that converts text data to voice. This makes it easy for customers to create voice messages, or text can be automatically read aloud by typing text in the command. In addition, since the voice synthesis engine is built into the main unit, voice conversion can occur even when offline (not connected to the internet).

Generate Voice File for Registration

Generate audio from text, register it to an audio channel, and play it back with a command. Compared to traditional recording methods, we have succeeded in dramatically reducing the time and effort required.

(Custom recording service is also available depending on customer's convenience, application and preference.)



Voice File Registration

Generate audio for registration from the web browser and register it to any channel.



Voice File Generation from Command

Characters you want spoken can be entered directly in the command and when a command is received the NHV will convert the text to voice and play it.

Command Example

<http://192.168.10.1/api/control?speech=Hello&lang=en>

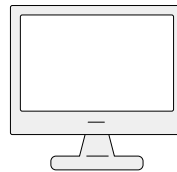

Temperature of the primary warehouse is abnormal. Please check immediately.

88dB

Loud, Clear Audio

In spite of its compact size, the unique horn structure achieves a sound pressure of more than 88dB (at 1m).

The clear audio makes it easier to distinguish the information.



Various settings and MP3 files can be uploaded from a web browser.

* Use Google Chrome / Microsoft Edge when setting up browsers.



Set 16 volume settings using the VOLUME buttons.

Volume change can be disabled in the software (in the browser settings) to prevent unintended changes in volume.

Volume + button

Volume - button

Error detected on the network

LINE OUT

Connection to Existing Broadcasting Equipment

Voice messages can be broadcast by connecting the digital output of the unit to an external amplifier.

* Built-in sounds cannot be output from LINE OUT.



LINE OUT

PA system, amplifiers, external speakers, etc.

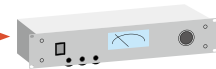

Coordinated with contact output

An error has occurred.

Coordinate Audio Playback and Contact Output

Digital contacts can be output during audio playback.

Voice output can be delayed to prevent it from starting before the amplifier starts.

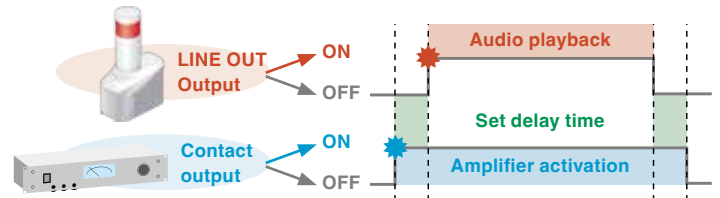

Standard Sound

Various Built-in Sounds

There are a total of 11 built-in audio data (5 alarms, 3 chimes, and 3 voice messages).

These are available from the time of shipment for network error notification.

Select alarms or messages according to monitoring requirements.

Built-in Sounds

Alarm Sounds

♪ (Beep, Beep, Beep); ♪ (Slower Beep); ♪ (Very slow, Beep);
♪ (Be-beep, Be-beep); ♪ (Beeee) (continuous sound)

Chime Sounds

♪ Chime 1 ♪ Chime 2
♪ Chime 3

Voice Messages

🗣️ An error was detected in the network. 🗣️ An error occurred.
🗣️ The error has been cleared.

Model Features

Digital Input/Output (D Model/DP Model)

Compatible with a wide range of applications, such as receiving information from sensors or sending digital signals to other devices when events trigger the NHV.

4 Digital inputs included

Monitor up to 4 outputs from equipment with digital output capability.

2 Digital Contact Outputs Included

Operate devices such as rotating beacons and voice annunciators.

Abnormal output from equipment such as switches and relays; contact output from sensors, etc.

IN



OUT



Rotating beacon, voice annunciator, entry and exit gate, etc.

Elapsed Time Operation

Light and sound can be activated based on elapsed time since the occurrence of the triggering event.

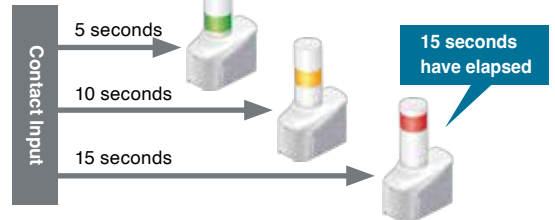

PoE Power (DP Model)

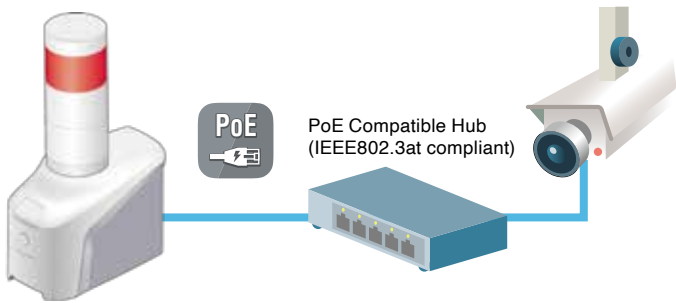

This model has the NHV-D features plus PoE power capability. It can be used in areas where it is difficult to secure power or to facilitate network camera connection. (IEEE802.3af compliant)

* If PoE power is used, a IEEE802.3af compliant PoE+ power supply (HUB, injector) is required. USB power cannot be supplied from the main unit's USB connector if an IEEE802.3af compliant PoE power supply is used.

Mail Reception Detection (M Model)

The NHV-M unit accesses the mail server and will light up or play a message when emails that meet preset conditions are received.

No PC is required because the NHV-M accesses the server directly, so no modification is needed to the existing system. It is compatible with "OAuth2.0*" as well as "Password Authentication".

* OAuth authentication is compatible with "Gmail" and "Outlook" only.

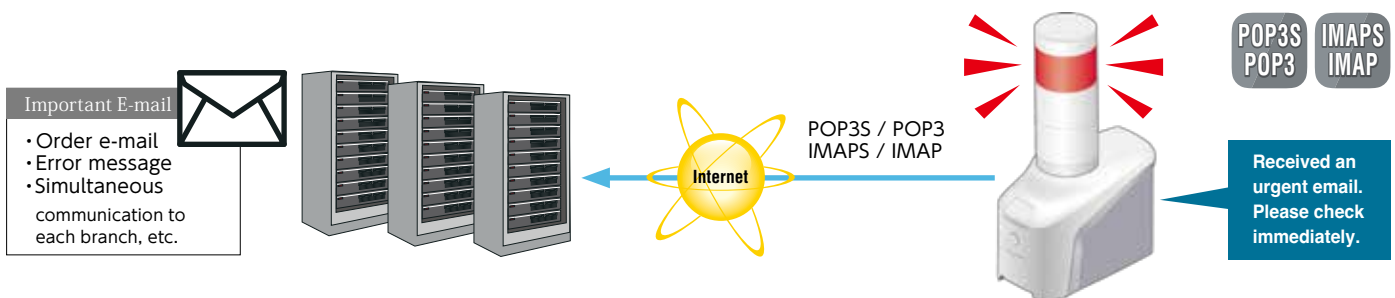

Detection Condition : "Sender (mail address)", "Subject" and "Body"
(Matches with above/ includes / does not include / starts with)
Number of Conditions : 20

Function List by Series

Model Number	NHV	NHV-D	NHV-DP	NHV-M
Dimming Function	○	○	○	○
Cloud Control	○	○	○	○
Send HTTP	○	○	○	○
Audio Playback (MP3)	○	○	○	○
TTS (Text to Speech)	○	○	○	○
Digital I/O (4 inputs/2 outputs)	—	○	○	—
PoE-powered * IEEE802.3af Compliant	—	—	○	—
Mail Detection Function	—	—	—	○

External Dimensions and Installation Method

External Dimensions/Operation Panel

NHV4 series

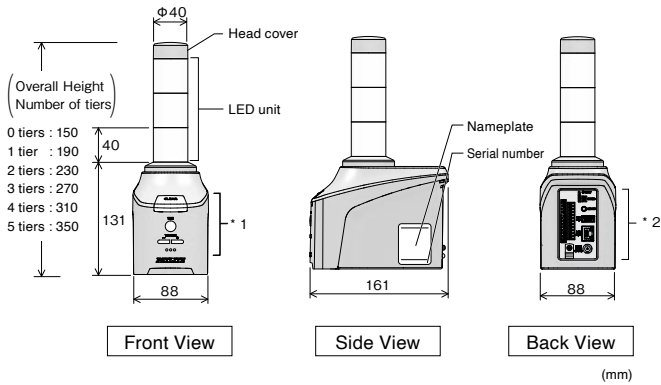

NHV6 series

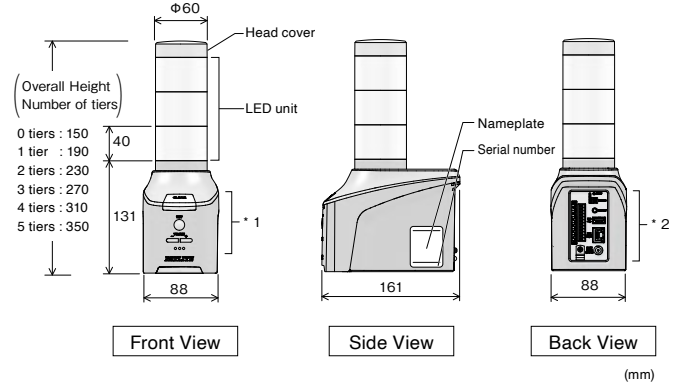

*1 Enlarged View

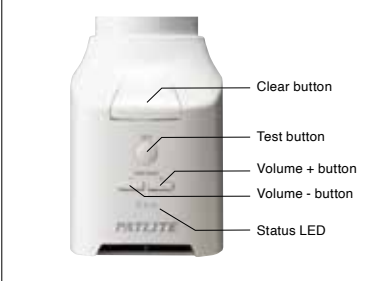

*2 Enlarged View NHV/NHV-M

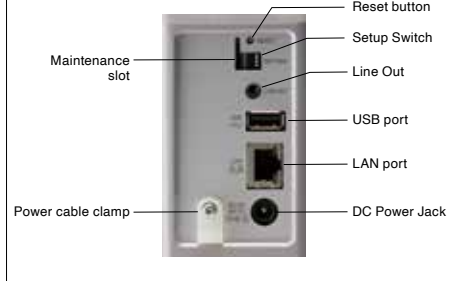

*2 Enlarged View NHV-D/NHV-DP

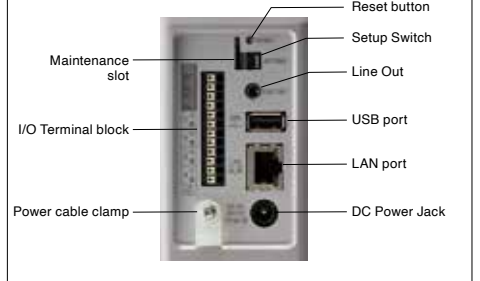

Installation

Stationary

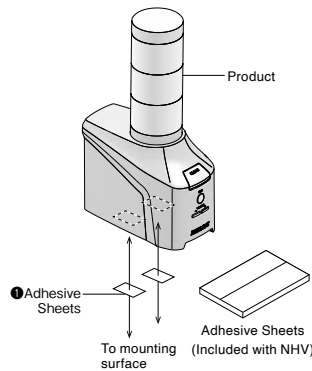

Tripod Mounting



Wall Mounting/VESA Mounting



Partition Mounting



Model Number	NHV	NHV-D	NHV-DP	NHV-M
DC24V AC adapter *1			○	
PoE Power Supply	—	—	○*2	—
Mounting Method	Upright			
Network Communication Method	Ethernet (IEEE 802.3 at Compliant) 10BASE-T / 100BASE-TX / 1000BASE-T (Auto MDI/MDI-X)			
IP Network	IPv4/IPv6 Dual-stack			
IP Address Setup	Manual setting and DHCP auto setting			
Ambient Temperature	0°C to 40°C			
Ingress Protection	IP20			
Supported Protocols	HTTPS/HTTP, SSH, RSH, SMTPS/SMTP, IMAPS/IMAP, POP3S/POP3, SNMP(v3 / v2c / v1), NTP			
Conformity Standards	UL62368-1, CSA C22.2 NO. 62368-1 FCC Part 15 Subpart B Class A EN 55032, EN 55035, EN IEC 63000 KS C 9610-6-4, KS C 9610-6-2*3 TR CU 020, TR EEU 037*3			

*1. N and DP models of each series are compatible with the AC adapter, the adapter is not supplied with the product.

*2. IEEE802.3at (PoE+) compliant. Please check the specifications of your device when powering with PoE.

*3. N and P specifications only

PATLITE® Global Network

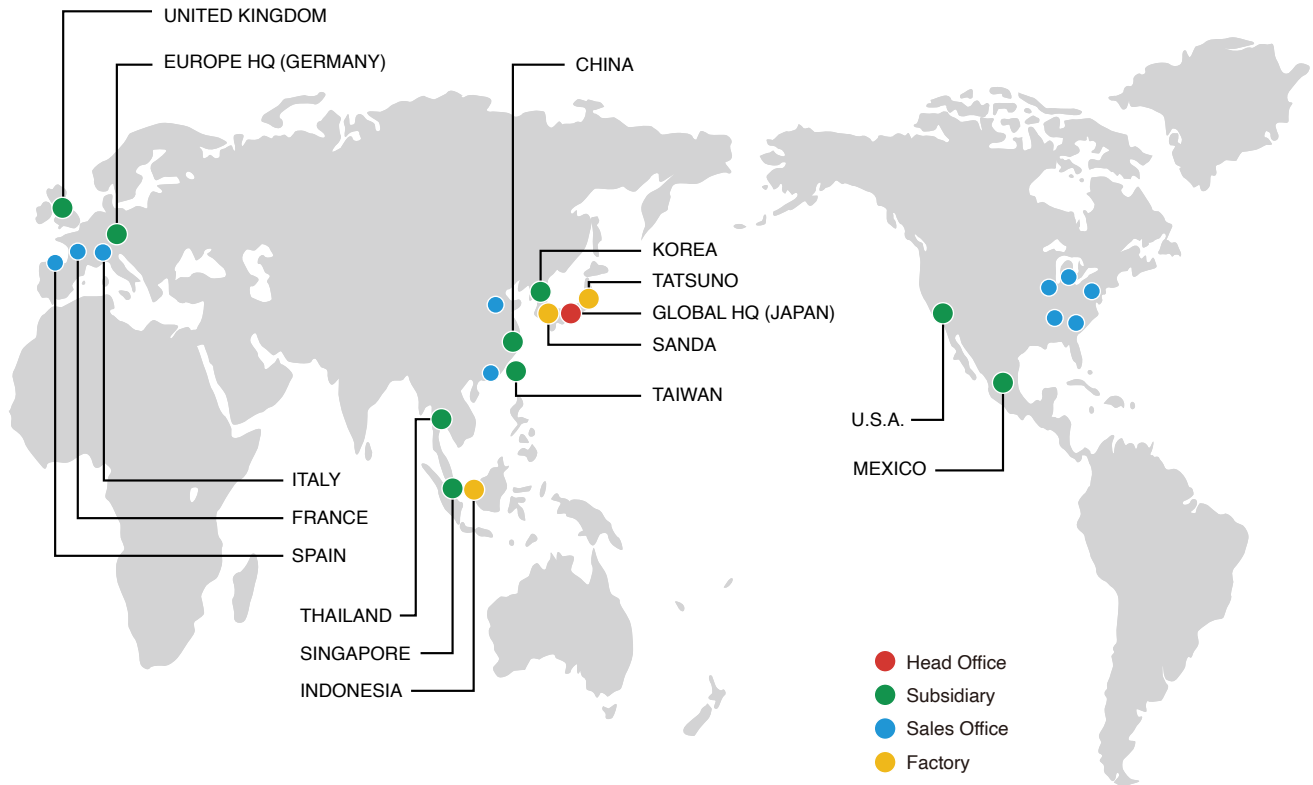

PATLITE Corporation

www.patlite.com

PATLITE (U.S.A.) Corporation

PATLITE KOREA CO., LTD.

PATLITE MEXICO S.A. de C.V.

PATLITE TAIWAN CO., LTD.

PATLITE Europe GmbH

PATLITE (THAILAND) CO., LTD.

PATLITE UK LTD

PATLITE (SINGAPORE) PTE LTD

PATLITE (CHINA) Corporation

PT. PATLITE INDONESIA

- PATLITE, the PATLITE logo are either registered trademarks or trademarks of PATLITE Corporation in JAPAN and/or other countries.
- MPEG Layer-3 audio coding technology licensed from Fraunhofer IIS and Thomson Licensing.
- The names of other companies and products are trademarks or registered trademarks of their respective companies.

⚠ CAUTION

To ensure correct use of these products, read the "Instruction Manual" prior to use. Failure to follow all safeguards can result in fire, electric shock, or other accidents. Specifications are subject to change without notice.